

Royal Exclusiv pumps & skimmers

Klaus Jansen // Richard-Byrd-Str.7 // 50829 Cologne // Germany

Fon +49(0)221/222886 0 // Fax +49(0)221/22288622

info@royal-exclusiv.de // www.royal-exclusiv.de



Since 1986



Data sheet and list of spare parts for Bubble King® DeLuxe 400
For all Bubble King® DeLuxe protein skimmer 400 external

vs14

ENG





Data sheet for protein skimmer Bubble King® DeLuxe 400 external

Protein skimmer Bubble King® DeLuxe 400 external Product no.: 82 **3.768,45 €**
for aquariums from 1.500 ltr. up to 4.000 ltr.

Skimmer-series Bubble King® DeLuxe for aquarium-grounds.

For external installation outside of filter-systems. For the demanding user.

Technical data Bubble King® DeLuxe 400:

3.500 ltr./h Air - 5.000 ltr./h Water = 1 pump Bubble King® 1500 / 1 pump Bubble King® 2000 with AKB- (anti-lime-bypass) for external use

Baseplate: 43 cm x 43 cm / height ~ 80 cm

Skimmer-pumps: 1x Bubble King® 2000 with AKB (anti-lime-bypass)
1x Bubble King® 1500 with AKB (anti-lime-bypass)

Delivery rate: 3.500 l/h Air inlet ~ 5.000 l/h Water inlet

Wattage - active power: P = 106 Watt/h (both pumps!)

Operating voltage: 230 Volt 50 Hz (also in 110V/60Hz available)

Protection class: IP 68

Connecting tube: 32 mm

Required performance of the drivers pump: 500 - 4.000 l/h

Weight skimmer: 27 kg inclusiv pump

Dimension skimmer without pump: 425 mm wide / 425 mm length / ~ 770 mm height

Dimension skimmer with pumps: 785 mm wide / 535 mm length / ~ 770 mm height

Heigth silicon outlet (cleanout) ~ 580 mm

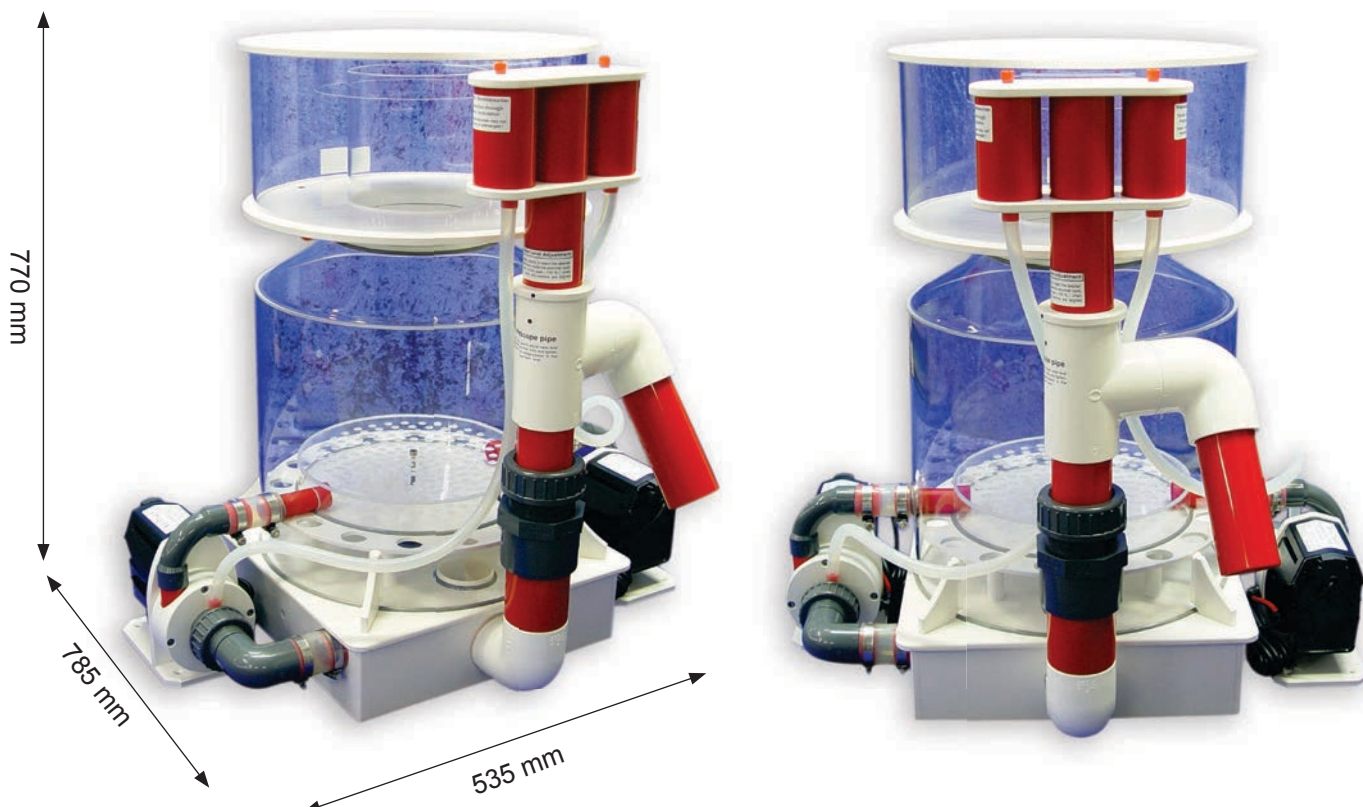

For more information, please visit www.royal-exclusiv.de. Simply enter the part number or name into the search box or email: info@royal-exclusiv.de.

All information subject to change. We try our best, but printing errors reserved.



Protein skimmer Bubble King® DeLuxe 400 intern Product no.: 82

Protein skimmer Bubble King® DeLuxe 400 for external filter assembly in aquariums of 1.500 l to 4.000 l.

The skimmer is equipped with two Red Dragon® Bubble King® skimmer pumps from Royal Exclusiv®, installed on the side. The complete piping technique is housed in the white PVC substructure.

A continuously height-adjustable telescopic tube is intended for water level regulation. The side vertical swivelling water outlet has a tube diameter of 63 mm. For the fine adjustment of the water level, there is also a 360° pivotable PVC torque tube with a fitted dismountable simple silencer.

The perforated Plexiglas lid can be opened by loosening the M6 titanium hexagon socket screw in the centre.

The complete skimmer cup can be unscrewed from the pillar tube. The lift height required for this is 30 mm. A pivotable tap is fitted to the bottom for draining off the absorbate.

The skimmer pumps are equipped with a descaling bypass. The connection of skimmer and pump is done, suction- and pressure-side with silicone hoses. This silicone hose connections are with V4A broadband clamps (hose band clips) secured. The 9 mm silicone tube connects the air intake between pumps and resonator.

For the operation of the skimmer an additional driver pump is to connect, which supplies the foamer with the water to be filtered. The sockets provided for this purpose has a diameter of 32 mm. The required performance of the drivers pump is located between 500 – 4.000 l/h.

Important maintenance information!!!

For the smooth functioning of the protein skimmer, the skimmer pump must be regularly cleaned and decalcified!





Protein skimmer Bubble King® DeLuxe 400 intern Product no.: 82

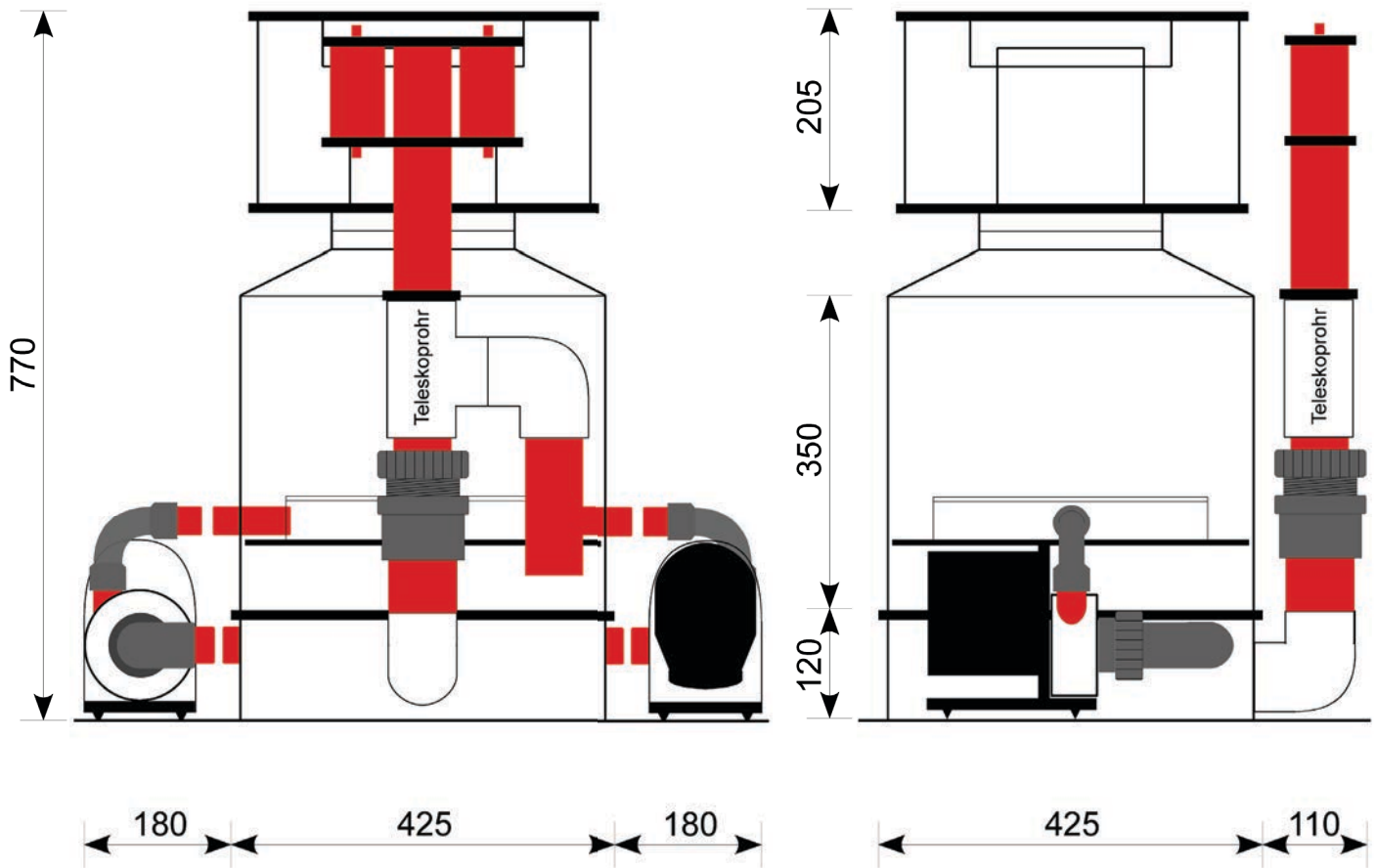

For more information, please visit www.royal-exclusiv.de. Simply enter the part number or name into the search box or email: info@royal-exclusiv.de.

All information subject to change. We try our best, but printing errors reserved.



Since 1986

**Protein skimmer Bubble King® DeLuxe 400 intern Product no.: 82**

list of spare parts	product no. (110V)	(230V)	Price
resonator double for Ø 63mm torque tube	294	294	82,95 €
silicon-outlet (cleanout)	298	298	23,52 €
lid complete with lever ring	315/14	315/14	126,00 €
cup with conus / stand pipe / cleanout	359/14	359/14	428,40 €
silicon O-ring 165x3,0mm for conus	333	333	8,72 €
silicon hose - Ø 30mm 50mm length	296-1	296-1	8,25 €
silicon hose - Ø 40mm 60mm length	296-2	296-2	9,45 €
V4A stainless hose band clip 25-40mm	197	197	8,19 €
V4A stainless hose band clip 32-50mm	198	198	10,08 €
torque tube Ø 63mm PVC red	347	347	49,35 €
titan screw for injection pan 6x45mm	183-5	183-5	8,09 €
silicon hose 9x3mm (price for one meter)	185	185	19,43 €
V4A screw 6 x 110mm for resonator / silencer	182-4	182-4	7,35 €
skimmer pump external BK 1500 complete	112/1-3	112/2-3	722,40 €
part motor block BK1500/2000 with AKB (anti-lime-bypass)	138/1-1	138/2-1	369,60 €
rotor complete with metal shaft for BK 1500	125/1-2	125/2-2	186,90 €
skimmer pump external BK 2000 complete	113/1-3	113/2-3	789,60 €
rotor complete with metal shaft for BK 2000	125/1-3	125/2-3	215,25 €
carbon bearing with O-ring 1 piece	155	155	6,83 €
pump head PVC white with AKB (anti-lime-bypass)	253	253	228,90 €
V4A screws for pump head 4 pieces	182	182	8,09 €
V4A screws for motor block 4 pieces 6x22mm	182-1	182-1	3,89 €
pump holder turned version 5°	152	152	114,45 €
rubber feet 4 pieces	180	180	4,20 €
nozzle 22mm with screw connection	277	277	33,59 €
union nut 40mm PVC	176-40	176-40	3,04 €
O-ring for screw connection 40mm	174-40	174-40	1,78 €
AKB (anti-lime-bypass) hose Ø 8mm red	295	295	4,20 €
silicon O-ring 90x2,5mm for pump head BK1500/2000	169	169	5,36 €
silicon O-ring 82x4,0mm for motor block BK1500/2000	170	170	4,67 €













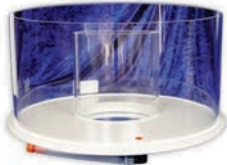

For the list of spare parts for Red Dragon® 3 skimmer pump see separate document.

Downloadable on our website under Red Dragon® 3 skimmer pump.

accessories	product no. (110V)	(230V)	Price
add on resonator Ø 63mm	999	999	33,60 €
PVC pipe clip Ø 63mm for wall and ceiling mounting	930-63	930-63	6,83 €
resonator - inlay	294-1	294-1	6,20 €
silicon grease tube 6g	030/6	030/6	2,63 €
silicon grease tube 25g	030/25	030/25	7,88 €

Protein skimmer Bubble King® DeLuxe 400 intern Product no.: 82

Please replace the **x** with the appropriate number for the voltage of 110/230 Volt.

<i>spare part</i>	<i>spare part</i>	<i>spare part</i>	<i>spare part</i>
			
resonator double for Ø 63mm torque tube 294 82,95 €	silicon-outlet (cleanout) 298 23,52 €	lid complete with lever ring 315/14 126,00 €	cup with conus / stand pipe cleanout 359/14 428,40 €
<i>spare part</i>	<i>spare part</i>	<i>spare part</i>	<i>spare part</i>
			
silicon O-ring 165x3,0mm for conus 333 8,72 €	silicon hose - Ø 30mm 50mm length 296-1 8,40 €	silicon hose - Ø 40mm 60mm length 296-2 9,45 €	V4A stainless hose band clip 25-40mm 197 8,19 €
<i>spare part</i>	<i>spare part</i>	<i>spare part</i>	<i>spare part</i>
			
V4A stainless hose band clip 32-50mm 198 10,08 €	torque tube Ø 63mm PVC 347 49,35 €	titan screw for injection pan 6x45mm 183-5 8,09 €	silicon hose 9x3mm (price for one meter) 185 19,43 €
<i>spare part</i>	<i>spare part</i>	<i>spare part</i>	<i>spare part</i>
			
V4A screw 6 x 110mm for resonator / silencer 182-4 7,35 €	skimmer pump external BK 1500 complete 112/x-3 722,40 €	part motor block BK1500/2000 with AKB 138/x-1 369,60 €	rotor complete with metal shaft for BK 1500 125/x-2 186,90 €

For more information, please visit www.royal-exclusiv.de. Simply enter the part number or name into the search box or email: info@royal-exclusiv.de.

All information subject to change. We try our best, but printing errors reserved.

Protein skimmer Bubble King® DeLuxe 400 intern **Product no.: 82**

Please replace the **x** with the appropriate number for the voltage of 110/230 Volt.

spare part	spare part	spare part	spare part
			
skimmer pump external BK 2000 complete 113/x-3 789,60 €	rotor complete with metal shaft for BK 2000 125/x-3 215,25 €	carbon bearing with O-ring 1 piece 155 6,83 €	pump head PVC white with AKB (anti-lime-bypass) 253 228,90 €
spare part	spare part	spare part	spare part
			
V4A screws for pump head 4 pieces 182 8,09 €	V4A screws for motor block 4 pieces 6x22mm 182-1 3,89 €	pump holder turned version 5° 152 114,45 €	rubber feet 4 pieces 180 4,20 €
spare part	spare part	spare part	spare part
			
nozzle 22mm with screw connection 277 33,59 €	O-ring for screw connection 40mm 174-40 1,78 €	union nut 40mm PVC 176-40 3,04 €	AKB (anti-lime-bypass) hose Ø 8mm red 295 4,20 €
spare part	spare part		
			
silicon O-ring 82x4,0mm for motor block BK1500/2000 170 4,67 €	silicon O-ring 90x2,5mm for pump head BK1500/2000 169 5,36 €		

For more information, please visit www.royal-exclusiv.de. Simply enter the part number or name into the search box or email: info@royal-exclusiv.de.

All information subject to change. We try our best, but printing errors reserved.



Protein skimmer Bubble King® DeLuxe 400 intern Product no.: 82

Please replace the **x** with the appropriate number for the voltage of 110/230 Volt.

accessories

accessories

accessories

accessories



add on resonator
Ø 63mm
999

33,60 €



PVC pipe clip Ø 63mm for
wall and ceiling mounting
930-63

6,83 €



resonator - inlay
294-1

6,20 €



silicon grease tube 6g

030-6

2,63 €

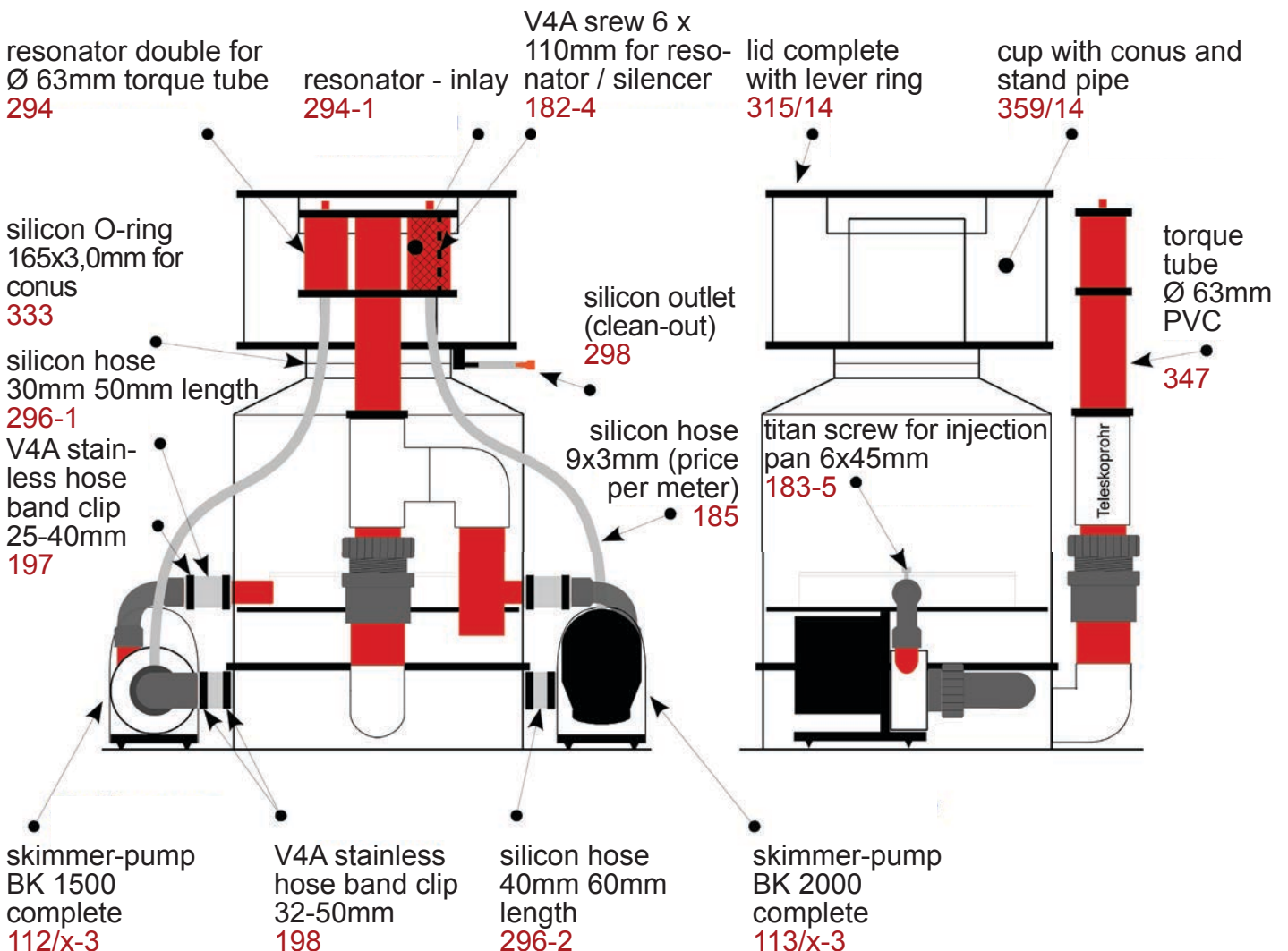

For more information, please visit www.royal-exclusiv.de. Simply enter the part number or name into the search box or email: info@royal-exclusiv.de.

All information subject to change. We try our best, but printing errors reserved.

Protein skimmer Bubble King® DeLuxe 400 intern **Product no.: 82**

Please replace the **x** with the appropriate number for the voltage of 110/230 Volt.

Protein skimmer pump Bubble King® 1500

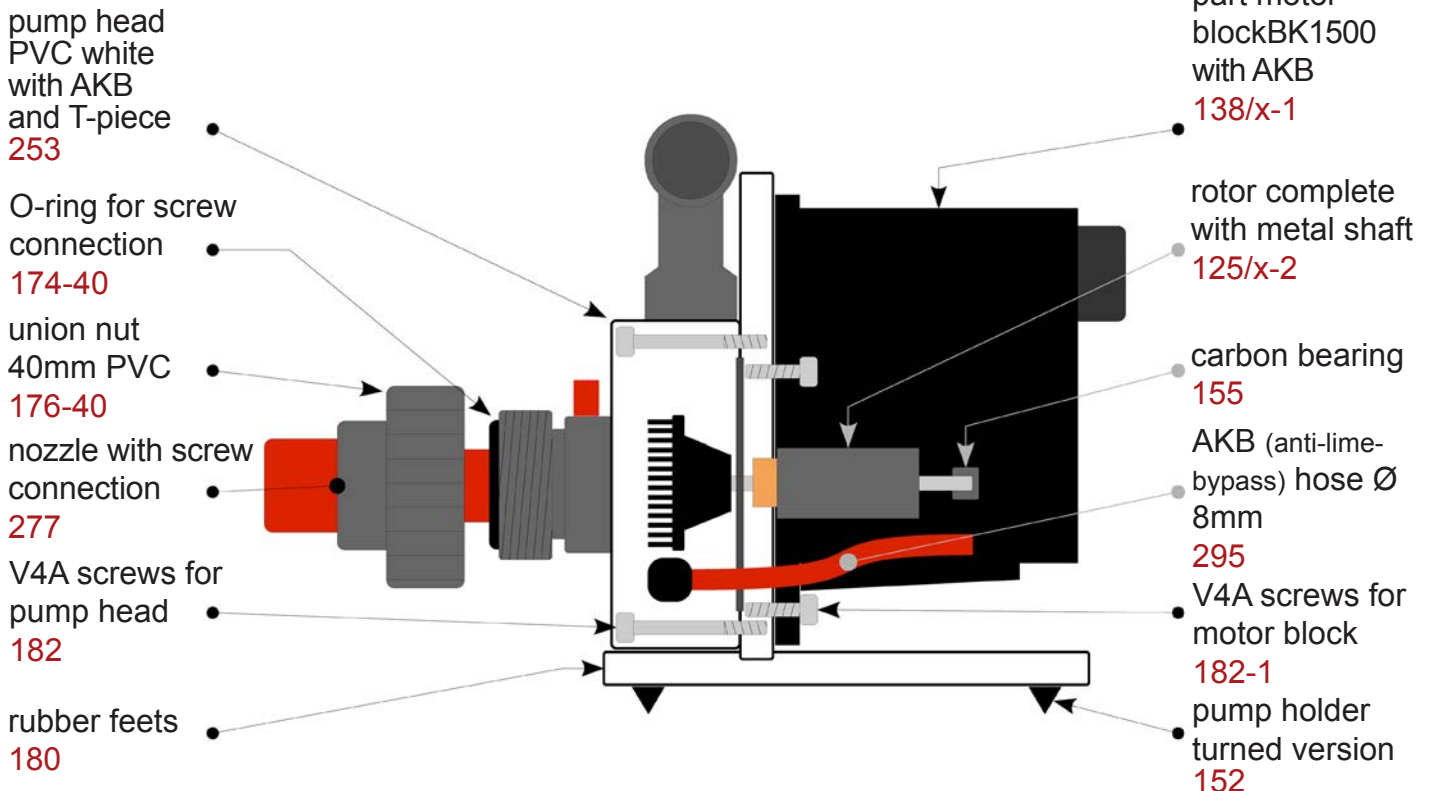

Protein skimmer Bubble King® DeLuxe 400 intern **Product no.: 82**

Please replace the **x** with the appropriate number for the voltage of 110/230 Volt.

Protein skimmer pump Bubble King® 2000

