

Royal Exclusiv pumps & skimmers

Klaus Jansen // Richard-Byrd-Str.7 // 50829 Cologne // Germany

Fon +49(0)221/222886 0 // Fax +49(0)221/22288622

info@royal-exclusiv.de // www.royal-exclusiv.de



Since 1986



List of spare parts for Bubble King® 2000 skimmer pump

For all Bubble King® 2000 protein skimmer pumps internal

v1.0

ENG

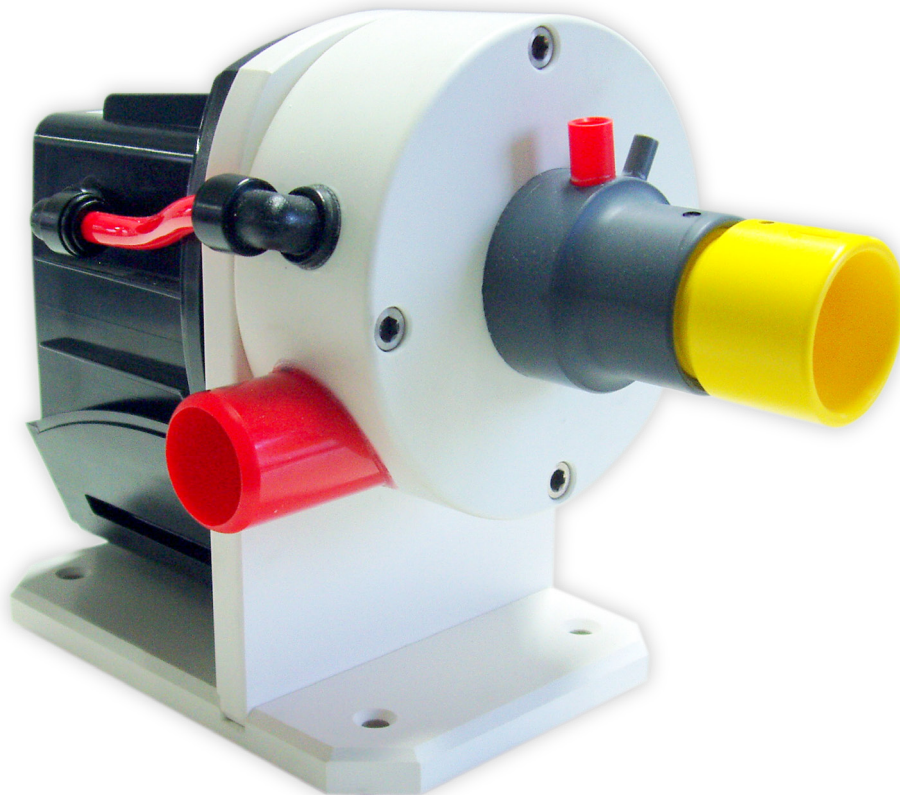



Bubble King® 2000 protein skimmer pump	Product no.: 113/x		624,00 €
<i>list of spare parts</i>	<i>product no. (110V)</i>	<i>(230V)</i>	<i>Price</i>
skimmer pump BK 2000 complete / normal	113/1	113/2	624,00 €
part motor block BK 2000 with AKB (anti-lime-bypass)	138/1-1	138/2-1	352,00 €
pump head PVC white with AKB (anti-lime-bypass)	250	250	195,20 €
rotor complete with metal shaft	125/1-3	125/2-3	205,00 €
carbon bearing 1 piece	155	155	6,50 €
titan screws for pump head 4 pieces	183	183	25,60 €
titan screws for motor block 4 pieces	183-1	183-1	11,70 €
pump holder normal PVC white	148	148	95,00 €
AKB (anti-lime-bypass) hose Ø 8mm red	295	295	4,00 €
nozzle - base part internal with ozon plug	284	284	16,80 €
nozzle 22mm	288	288	18,30 €
silicon tube 32mm 75mm length	296	296	7,85 €
rubber feet 4 pieces	180	180	4,00 €
silicon tube 9x3mm (price per meter)	185	185	18,50 €
silicon O-ring 90 x 2,5mm for pump head	169	169	5,10 €
silicon O-ring 82x4mm for motor block	170	170	4,45 €

accessories	product no. (110V)	(230V)	Price
add on resonator Ø 63mm	999	999	32,00 €
PVC pipe clip Ø 63mm for wall and ceiling mounting	930-63	930-63	6,50 €
resonator - inlay	294-1	294-1	5,90 €
silicon grease tube 6g	030/6	030/6	2,50 €
silicon grease tube 25g	030/25	030/25	7,50 €

accessories



add on resonator
Ø 63mm
999 32,00 €

accessories



PVC pipe clip Ø 63mm for
wall and ceiling mounting
930-63 6,50 €

accessories



resonator - inlay
294-1 5,90 €

accessories



silicon grease tube 6g
030-6 2,50 €











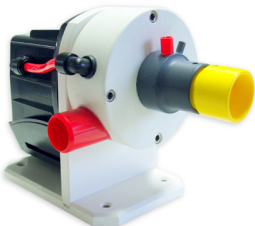



For more information, please visit www.royal-exclusiv.de. Simply enter the part number or name into the search box or email: info@royal-exclusiv.de.

All information subject to change. We try our best, but printing errors reserved.

Bubble King® 2000 protein skimmer pump

Product no.: 113/x

Please replace the **x** with the appropriate number for the voltage of 110/230 Volt.

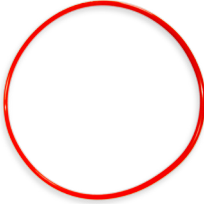
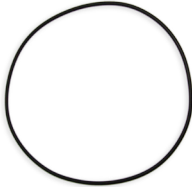
<i>spare part</i>	<i>spare part</i>	<i>spare part</i>	<i>spare part</i>
			
skimmer pump BK 2000 complete / normal 113/x 624,00 €	part motor block BK 2000 with AKB (anti-lime-bypass) 138/x-1 352,00 €	pump head PVC white with AKB (anti-lime-bypass) 250 195,20 €	rotor complete with metal shaft 125/x-3 205,00 €
<i>spare part</i>	<i>spare part</i>	<i>spare part</i>	<i>spare part</i>
			
carbon bearing 1 piece 155 6,50 €	titan screws for pump head 4 pieces 183 25,60 €	titan screws for motor block 4 pieces 183-1 11,70 €	pump holder normal PVC white 148 95,00 €
<i>spare part</i>	<i>spare part</i>	<i>spare part</i>	<i>spare part</i>
			
AKB(anti-lime-bypass) tube / hose Ø 8mm red 295 4,00 €	nozzle - base part internal with ozon plug 284 16,80 €	nozzle 22mm 288 18,30 €	silicon hose Ø 32mm 75mm length 296 7,85 €
<i>spare part</i>	<i>spare part</i>	<i>spare part</i>	<i>spare part</i>
			
rubber feet 4 pieces 180 4,00 €	silicon hose 9x3mm (price per meter) 185 18,50 €	silicon O-ring 90 x 2,5mm for pump head 169 5,10 €	silicon O-ring 82x4mm for motor block 170 4,45 €

For more information, please visit www.royal-exclusiv.de. Simply enter the part number or name into the search box or email: info@royal-exclusiv.de.

All information subject to change. We try our best, but printing errors reserved.



Bubble King® 2000 protein skimmer pump

Product no.: 113/x

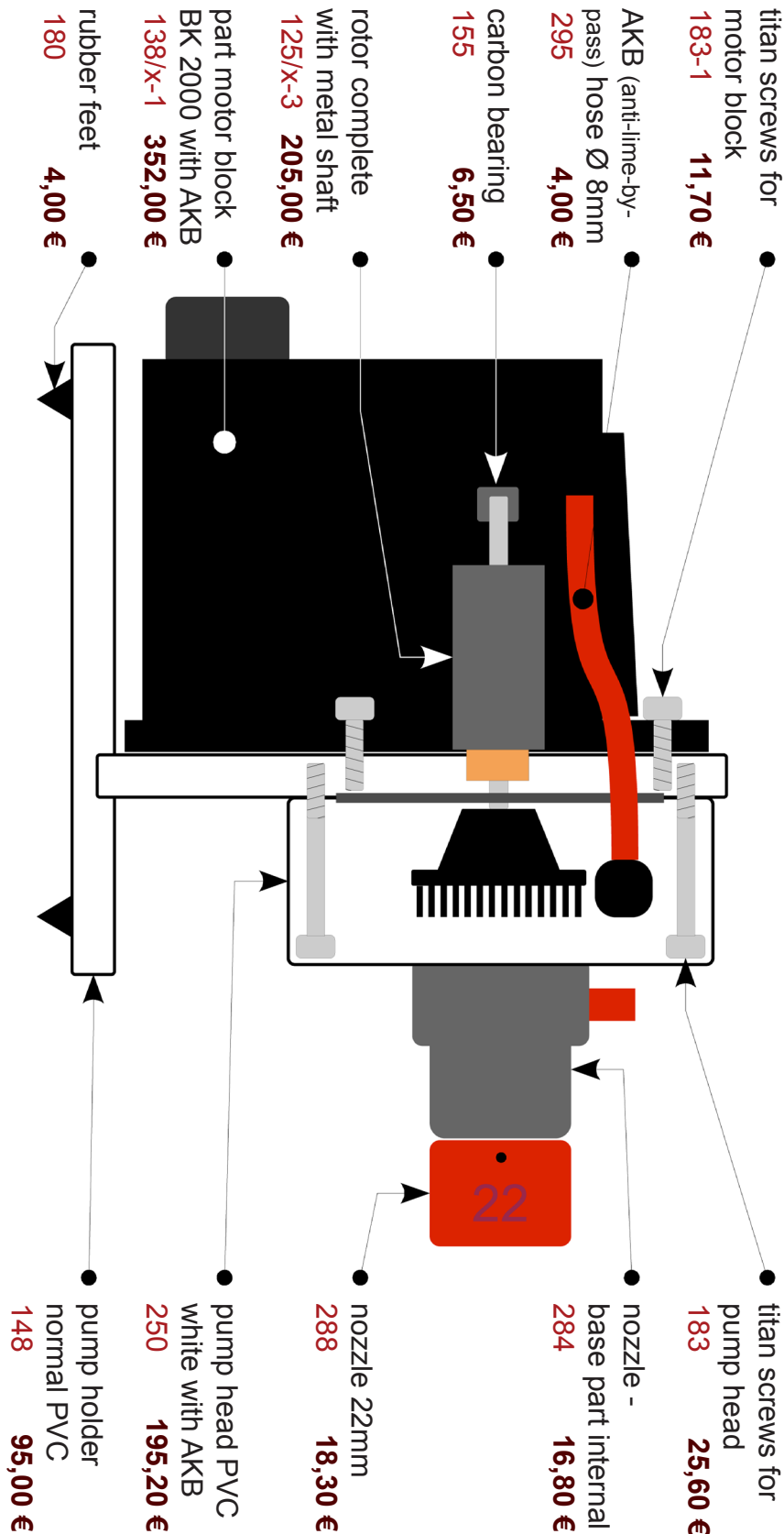

For more information, please visit www.royal-exclusiv.de. Simply enter the part number or name into the search box or email: info@royal-exclusiv.de.

All information subject to change. We try our best, but printing errors reserved.